



soundec

## ACOUSTIC PANELS

Wood fiber decorative  
acoustic panels

Eco-friendly and durable  
sound-absorbing material

# soundec

## SOUNDEC

Soundec- pressed wood fiber decorative acoustic panels with cement bonding produced in the Russian Federation.

The main components of Soundec panels are water, wood and white cement. Thanks to the properties this composition and structure, which are proven over decades of building practice, Soundec panels are environmentally friendly and durable. They are perfect for any interior, effectively reducing room reverberation. Depending on the thickness of fibers and the density of panels, a suitable modification with the necessary coefficient of sound absorption can be selected.

This material is suitable both for walls and for standard suspended ceiling systems.

Custom-shaped panels can be manufactured according to an individual design project; panels can be painted any shade according to NCS and RAL catalog.

### APPLICATION

- cafes, restaurants
- shopping centers
- offices, meeting rooms
- conference halls
- classrooms and lecture halls
- music studios
- gyms
- concert halls, theaters and movie theaters
- home studios and home theaters

### Modification

Modifications are characterized by the following specifications:

fiber width:

- 1 mm
- 1.5 mm

panel thickness:

- 14 mm
- 25 mm



1 mm



1,5 mm

### Sizes

Standard panel sizes, mm:

width: 300, 600

length: 300, 600, 1200, 1800, 2400

### Acoustic performance

Average sound absorption coefficient:

- Soundec S14: NRC=0,4
- Soundec S25: NRC=0,6
- Soundec S14 + StopZvuk BP at a space of 50 mm: NRC=0,9
- Soundec L24: NRC=0,5



Frequency characteristics of sound absorption coefficients for Soundec material

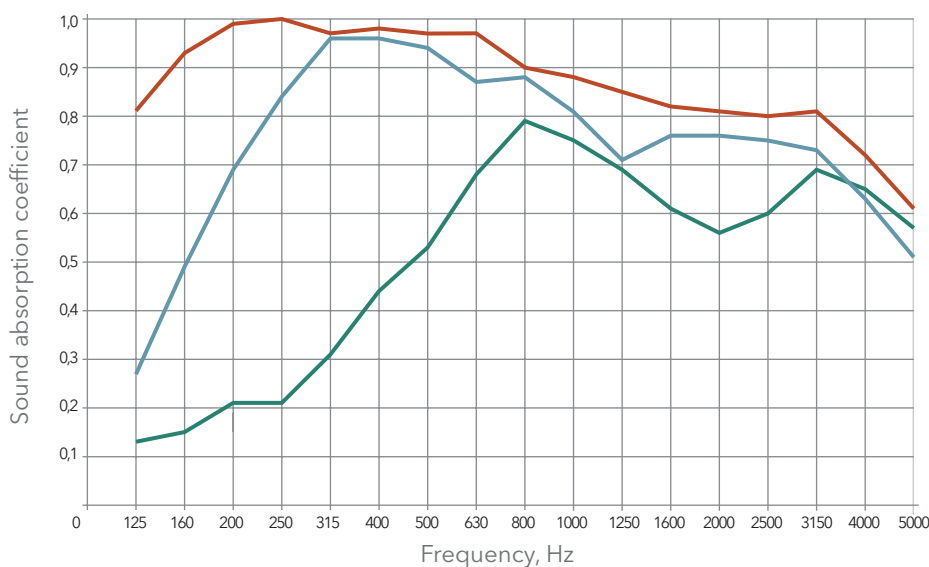

- Soundec 15 mm thickness, at 50 mm space.
- Soundec 25 mm thickness + StopZvuk BP at 50 mm space.
- Soundec 25 mm thickness + StopZvuk BP, double layer at 100 mm space.

Acoustic panels Soundec are factory painted with a primer (color RAL1015). Panels can be painted any shade according to scale NCS and RAL. Panels are painted by spraying water-based paints in a special shop. Panels can also be painted at the premises; the paint coating will be less uniform than factory-painted.

## Edges of acoustic panels

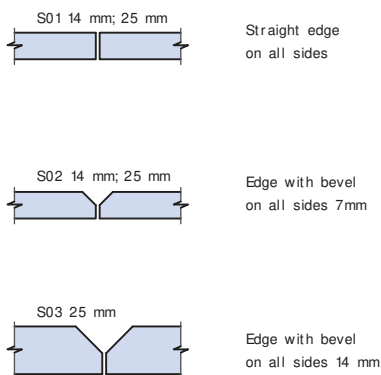

## For suspension system

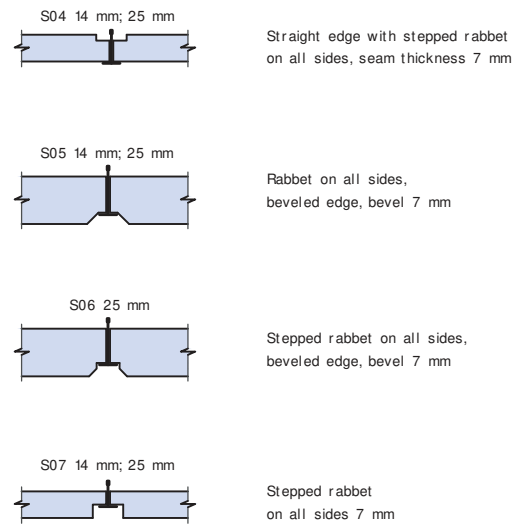

For mobile suspended ceilings, it is recommended that panels be mounted on visible profile systems. This provides easy access to communication lines. If necessary, the panels in profile systems can be simply removed to access communication lines.

Flush mounting is possible which makes the surface of panels even hiding all fasteners. Panels Soundec are installed directly on wooden or metal rails on the ceiling or walls or on profiles when installing suspended ceilings.

### Option 1

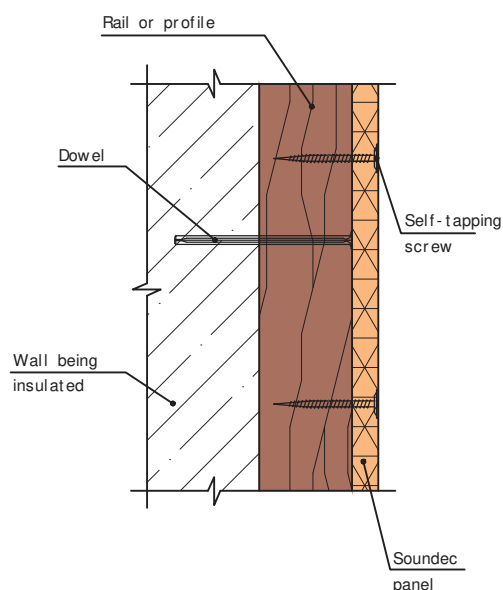

### Option 2

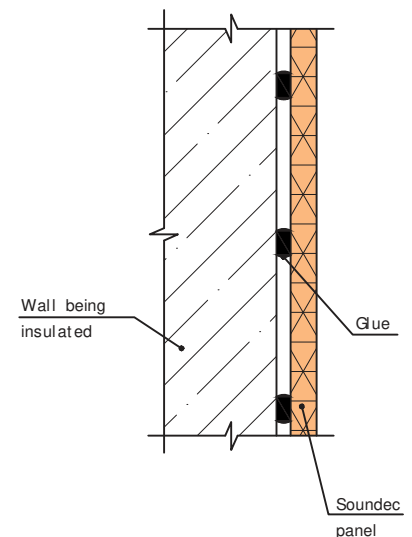

Installation process of Soundec panels



# soundec

## 3D SERIES

Soundec 3D Series – assortment of sculptured acoustic wall panels that can transform any surface into a work of art. Together, elements of the interior design form a functional acoustic art object.

Various color combinations are used for decorative acoustic walls panels' designs.

The limitless combinations of this product allow the creation of various striking interior effects: from warm romantic to expressive futuristic.

Soundec 3D Series panels have a square shape, with each side 290 mm and can be manufactured in three modifications: thickness of 25, 50 and 70 mm.

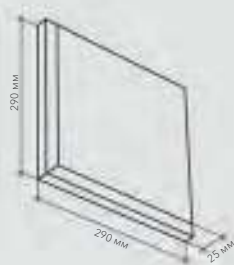

25 mm

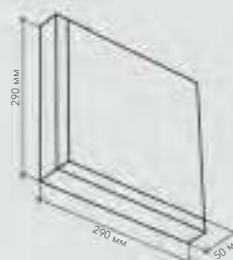

50 mm

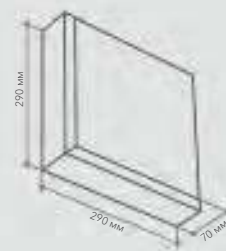

70 mm



Soundec Design Series is a variety of Soundec decorative acoustic panels. This series offer many possibilities for designing sound-absorbing panels of non-standard shapes.

Virtually any design fantasy can be put into practice. The abundance of forms, the ability to choose any size, as well as a number of additional options make this series of panels truly individual.

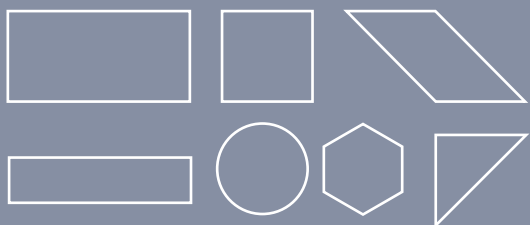

Soundec Design Series panels can be manufactured with bevels. Different combinations of line directions makes panels unique.

# soundec DESIGN SERIES

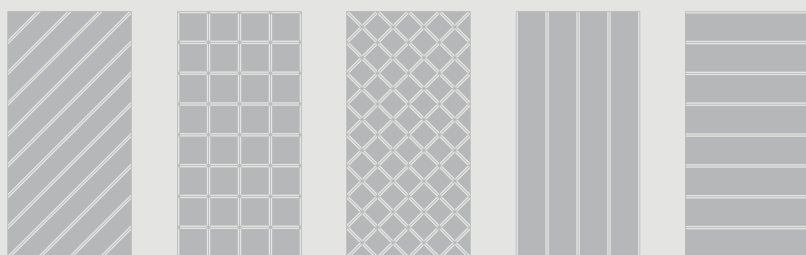

Soundec Design Series panels can be manufactured with bevels. Different combinations of line directions makes panels unique.





# soundec

## DESIGN SERIES

Soundec Design Series is sound-absorbing material, which, thanks to a special painting method, allows to achieve an extraordinary visual effect. The painting process takes place in two stages at a different angle; as a result, the decorative panel acquires a double shade, which emphasizes the depth and natural relief of wood fibers.



Panels Soundec



A special technology can give the effect of an aged surface to the upper layer of Soundec Design Series panels. After being painted, the top layer of the panel acquires a noble shine. This is an ideal option for creating a stylish room.



Soundec Design Series panels open up new possibilities for interior designers thanks to variations in form and color of individual panels and the option of combination of two shades on one panel.

CREATIVITY

• INNOVATION

• PROGRESS